

Installing a safety switch button







1. Introduction



This manual is a shortened version of the manual for the sauna emergency shutdown module. Before starting the installation, it is essential to read the safety rules described and detailed in the instructions for the emergency shutdown module of the sauna. Instructions can be downloaded from the website <https://ffes.pl/en/download/>

2. Set composition

Position	Name	Quantity	Photo
1	Switch	1	
2	Mounting bracket (part A+B)	1	
3	Case	1	
4	Screw $\varnothing 3 \times 12 \text{mm}$	8	

3. Tools needed for assembly

- Screwdriver
- Hole saw $\varnothing 30 \text{mm}$
- Phillips screwdriver



Before starting assembly work, turn off the power supply to the device in which the safety switch will be connected!

4. Switch placement

When assembling the safety switch, consider the following:

- Easy access, in a safe environment,
- location in the entrance/exit area,
- install the switch at a height of 100 cm from the floor, at a distance of min. 50 cm from heating devices (e.g. stove),

Example of the position of the sauna safety switch:

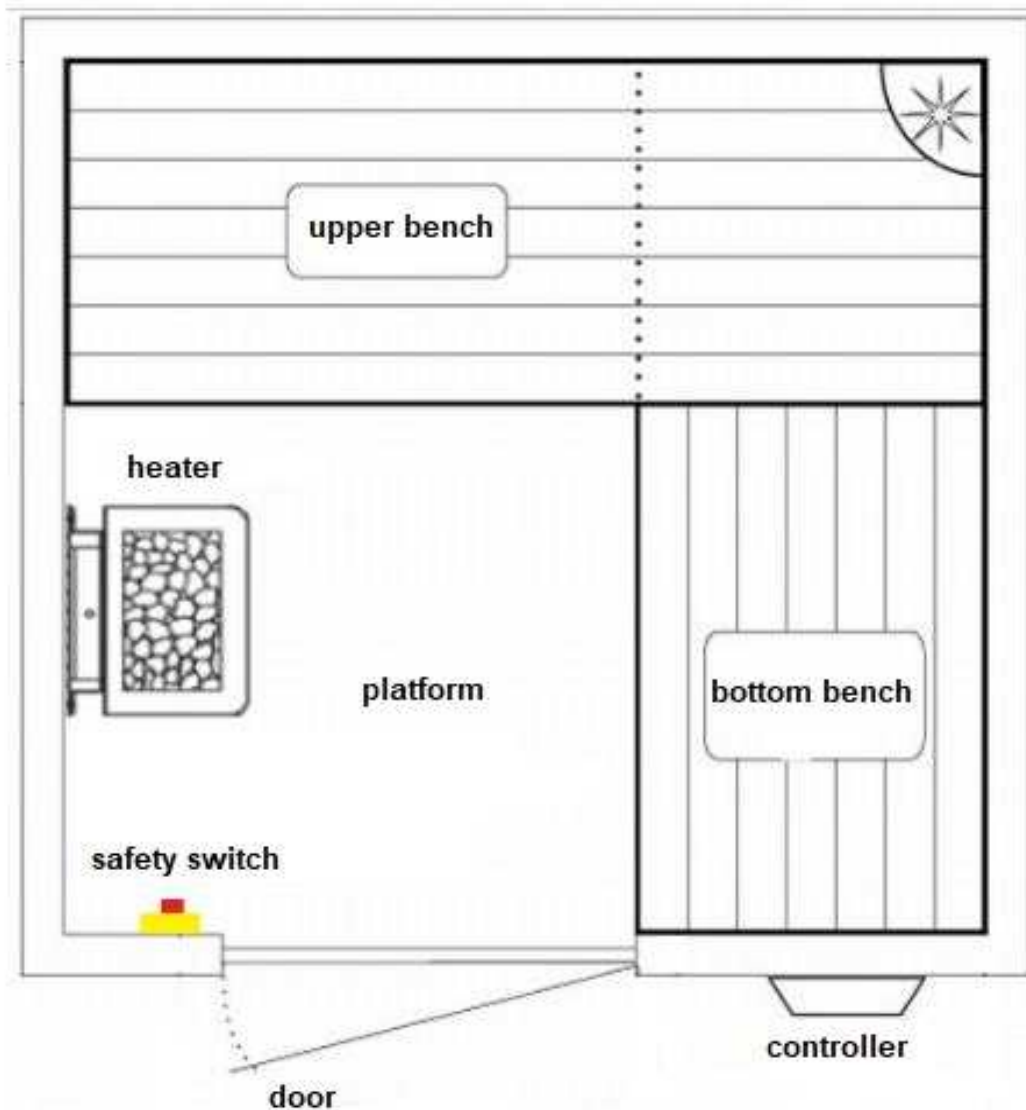

5. Assembly of the switch

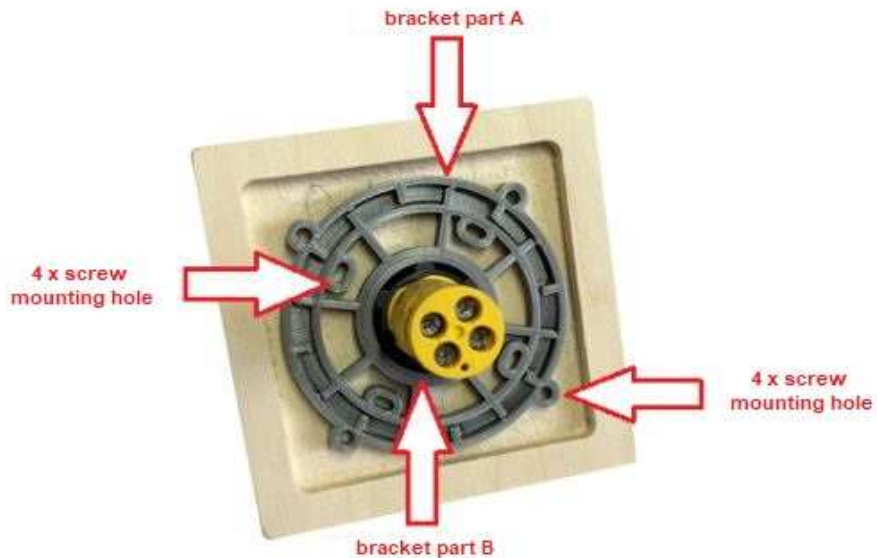

Sequence of activities:

- Make a hole in the wall $\varnothing 30$ mm
- Mount the bracket-part A (in the axis of the hole-use the pre-assembled bracket from parts A+B for alignment) to the wall with screws (pos. 4 - 4 pcs);
- Mount the bracket - part B (in the axis of the hole) to the wooden housing with screws (item 4 - 4 pcs);
- Install the switch in the housing;
- Connect the signal cables;
- Apply the armed switch to the bracket A installed on the wall, then rotate until the latches engage (if necessary, make adjustments with the slotted holes part B).

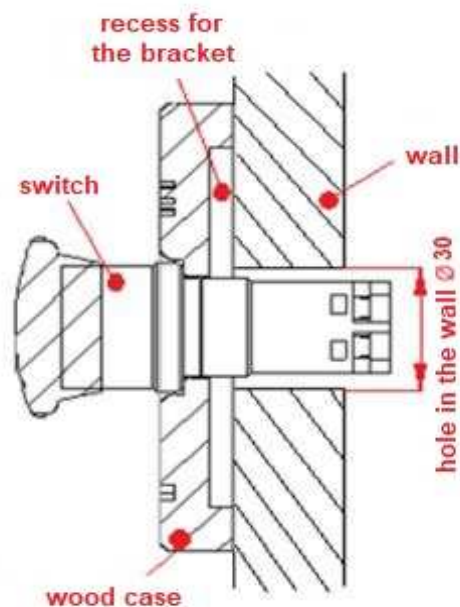

6. Connecting the safety switch to the main board of the power module of the ZXX, CXX, CXXmini series FFES controller

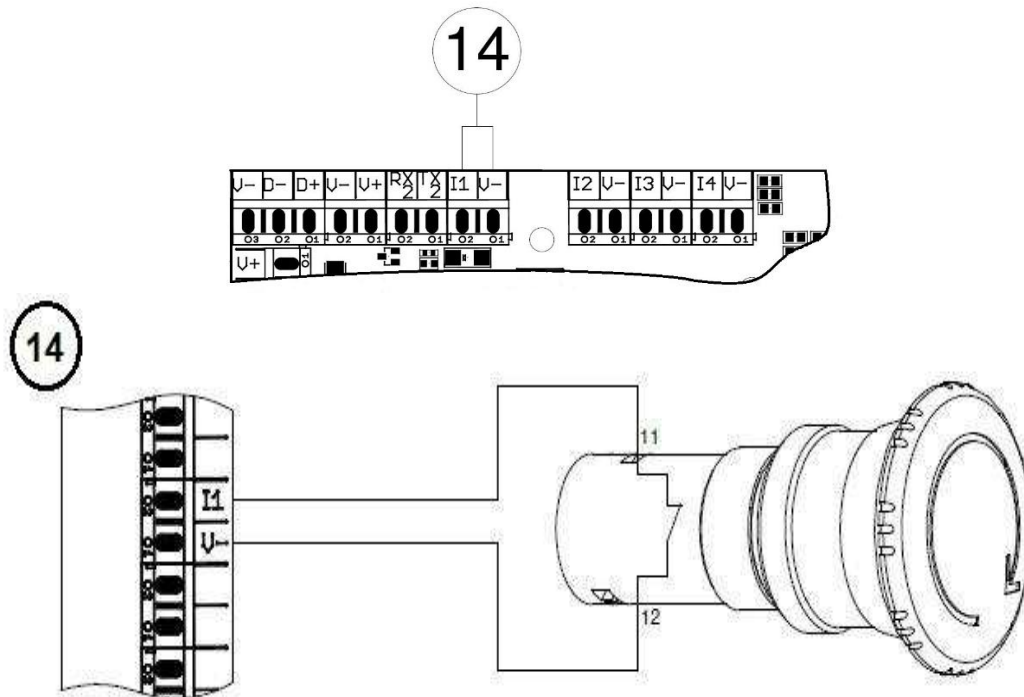

7. Principle of operation of the sauna emergency switch

Emergency power off - press the button to its limit, the button will snap into place and remain in that position.

Switching on the power supply - before restarting the power supply of the sauna, first make sure that there is no danger to human health and life. Turn the red part of the button as indicated by the arrow and pull it towards you. The button will snap into place and remains in that position.